

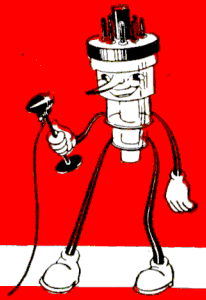

Electronic
TUBE

Ham News

Copyright 1952, by General Electric Company



MAY—JUNE 1952

VOL. 7—NO. 3

6-METER CD RCVR

Specialized Six-tube Superhet for CD Use

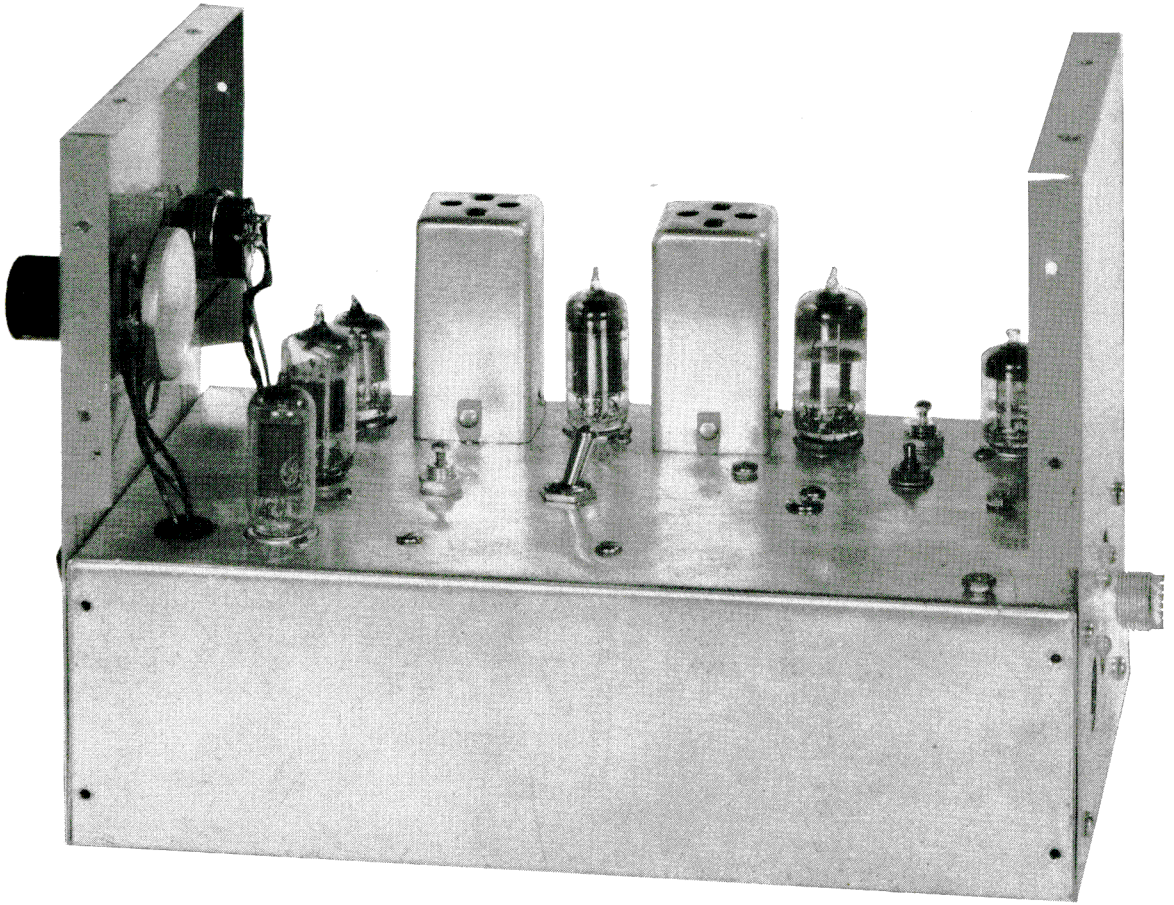

Fig. 1. Side view of the 6-Meter CD Receiver

Contents

6-Meter CD Receiver.....	pages 1-6
Sweeping the Spectrum.....	page 7
Technical Information (6BJ6).....	page 8

6-METER CD RCVR

This six-meter receiver is a companion unit to the six-meter transmitter described in the January-February 1952 *Ham News*. It is identical in size and shape. The two units together make an ideal transmitter-receiver combination for civil defense use.

The September-October 1951 issue of *Ham News* described a six-meter receiver useful for all purposes. This receiver had excellent sensitivity, and yet was relatively simple, design-wise. Many civil-defense amateurs throughout the country, recognizing the design merit of this receiver, wrote in asking if it could be redesigned specifically for CD use. The 6-meter CD Receiver described in this issue is in answer to these requests.

DESIGN CONSIDERATIONS

The original receiver design, while quite simple, was still too complex for CD use. For example, there were nine front-panel controls or jacks. These included tuning, a.f. gain, r.f. gain, BFO pitch control, BFO on-off control, ANL limiter control, ANL on-off switch, AVC on-off switch and headphone jack. Seating an untrained amateur, or at least an amateur unfamiliar with the controls, in front of such a receiver would be like asking a pilot who has just soloed to fly a B-36 bomber.

In civil defense work almost any amateur may be called upon to operate a given installation. For this reason controls must be kept to a minimum. The 6-Meter CD Receiver uses only three front-panel controls; namely, tuning, gain and ANL control. Despite this, practically none of the original features

have been omitted. The BFO on-off switch is available by removing the top cover. In this position it cannot accidentally be turned on, and yet if you wish to use c.w. the BFO may be easily turned on. Similarly, the BFO pitch control is a slug-tuned coil.

The redesign has been carried out in two directions. As just explained, the mechanical layout has been greatly altered to provide a functional receiver. Further, the circuit has been simplified. The original receiver tuned from 50 to 54 megacycles. This required that the r.f. stage track with the oscillator. The tracking problem has been eliminated by designing the CD Receiver so that it covers only a small portion of the six-meter band. Two civil defense segments of the six-meter band, as specified under the new RACES rules, are: 50.35 to 50.75 and 53.35 to 53.75 megacycles. Each segment covers 400 kilocycles, or can be considered to cover twenty 20 kilocycle channels. The 6-meter CD Receiver has been designed to cover 200 kilocycles in either of the two segments. However, note that normally the receiver will be built to operate in only one of these two segments. That is to say, the coils will cover either the high or the low segment, but the receiver must be tuned to just one of the segments. The tuning control will then cover any 200 kilocycle portion of the 400 kilocycle wide segment.

RECEIVER FEATURES

Six tubes are employed in a full superheterodyne circuit. A noise limiter and a BFO are included in the circuit. The output tube will drive a speaker, although headphones may also be used.

Electrical Circuit

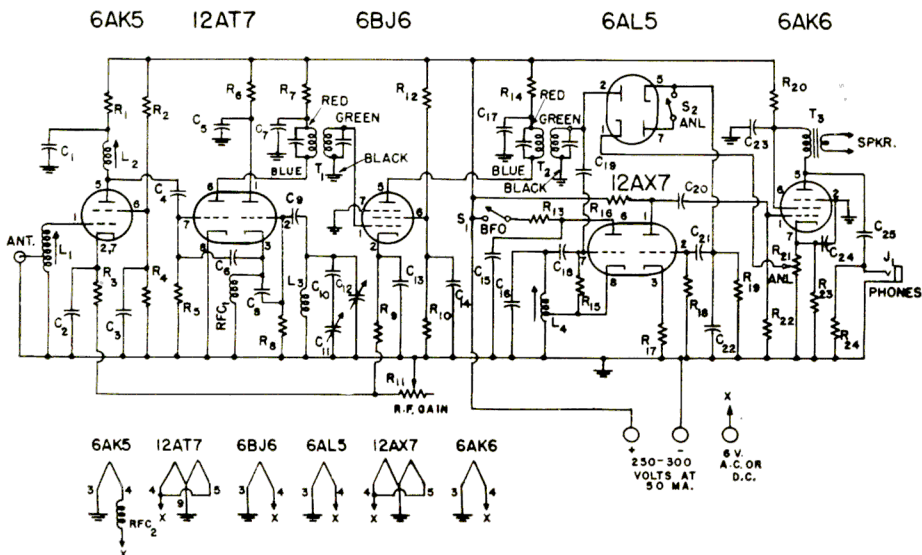

Fig. 2. Circuit Diagram of the 6-Meter CD Receiver

Sensitivity is excellent, and the receiver has a noise figure of approximately 5 to 7 db.

Selectivity is adequate for CD use. Considering twenty-kilocycle channels, selectivity is not good enough for adjacent-channel rejection. However, this situation will rarely be found in CD operation. The actual band width is in the order of plus or minus twenty-five kilocycles, to the half-power point.

Current drain is approximately fifty mills, and the voltage required is 250 to 300 volts.

All components specified have adequate safety factor insofar as voltage and wattage rating is concerned. For this reason, continuous, day-after-day operation, at 24 hours per day, is easily possible.

CIRCUIT DETAILS

Refer to the circuit diagram, Fig. 2. The 6AK5 tube serves as a broad-band r.f. amplifier. Coils L_1 and L_2 will resonate in the middle of either the high-frequency or the low-frequency segment of the six-meter band, depending on how the slug is adjusted. The 12AT7 tube serves as the local oscillator and the mixer, one section of the tube being used for each function. Oscillator output voltage is taken from the cathode and coupled through C_6 to the grid of the mixer section. The tuning condenser, C_{10} , is placed in series with a small capacitance, C_{11} , so that the tuning range is restricted to 200 kilocycles. Effectively this series circuit makes C_{11} look as though it has a very small capacitance.

The mixer feeds a 6BJ6 which acts as the i.f. amplifier stage. This tube, in turn, feeds a 6AL5 tube which acts as the sound detector, and also serves as the noise limiter diode. One section of a 12AX7 tube is the first audio amplifier stage, while the other section is the beat-frequency oscillator. The output

stage is a 6AK6 which is capable of a power output of approximately one watt.

The oscillator is designed to work on the high side of the received signal in order to avoid receiving troublesome images. The only image that can possibly cause trouble, with the oscillator working as shown, is the video signal from a channel 3 television station, but inasmuch as this falls at 51.25 megacycles, and is outside the two CD segments, this is not serious.

The intermediate-frequency chosen for the i.f. stage is 5 megacycles. The reason for this is thoroughly discussed in *Ham News* for September-October 1951. Because no regular i.f. transformers are available for this frequency, they must be home-made. The details of this will be discussed later.

No audio gain control is used in the circuit, as it was not deemed necessary. Audio "loudness" in the speaker or headphones is controlled by the r.f. gain control, R_{11} . Of course, if it seems desirable, an audio gain control can be added. Merely replace R_{22} with a 0.5 megohm potentiometer, connecting the grid of the 6AK6 to the arm of the potentiometer.

The noise limiter is a parallel clipper circuit whose clipping level is adjusted by means of R_{21} . The noise-limiter switch is attached to this potentiometer. Inclusion of a noise-limiter in the receiver circuit is the result of experience. In time of emergency, especially around a radio center, there will be many cars with their motors idling. A noise limiter is a necessity in a CD receiver.

The circuit for this receiver contains everything which is necessary for civil-defense work, and yet contains nothing which is unnecessary. It is strictly a down-to-business communication receiver, designed to do a given job well.

CIRCUIT CONSTANTS

(All resistors and capacitors $\pm 20\%$ tolerance unless specified otherwise)

C_1, C_2, C_3, C_5	270 mmf mica or high-K ceramic	R_2	47,000 ohm, 2 watt
C_4	1000 mmf mica or general purpose ceramic	R_3	220 ohm, $\frac{1}{2}$ watt
C_6, C_{10}, C_{19}	2 mmf silver mica (see text)	R_4	47,000 ohm, 1 watt
C_7, C_{13}, C_{15}	0.005 mica, paper or high-K ceramic	R_5, R_{24}	1.0 megohm, $\frac{1}{2}$ watt
C_8	5 mmf mica or general purpose ceramic	R_6, R_7	4700 ohm, 2 watt
C_9	10 mmf mica or general purpose ceramic	R_8, R_{18}	0.1 megohm, $\frac{1}{2}$ watt
C_{11}	4-15 mmf variable air condenser (Hammarlund HF-15-X)	R_9	68 ohm, $\frac{1}{2}$ watt
C_{12}	15-120 mmf mica compression trimmer (El-Menco 302-M)	R_{10}	68,000 ohm, 2 watt
C_{14}, C_{20}, C_{21}	0.001 mica, paper or high-K ceramic	R_{11}	5000 ohm potentiometer 4 watt (Mallory M5MP)
C_{16}, C_{22}	100 mmf mica or general purpose ceramic	R_{12}	39,000 ohm, 2 watt ($\pm 10\%$)
C_{17}	0.01 mica, paper or high-K ceramic	R_{13}	0.1 megohm, 1 watt
C_{18}	50 mmf mica or general purpose ceramic	R_{14}	15,000 ohm, 2 watt
C_{23}	8 mf 450 volt electrolytic	R_{16}	330,000 ohm, 1 watt
C_{24}	50 mf 25 volt electrolytic	R_{17}	330 ohm, 1 watt
C_{25}	0.05 mica, paper or high-K ceramic	R_{18}, R_{22}	470,000 ohm, $\frac{1}{2}$ watt
J	Open circuit phone jack	R_{19}	220,000 ohm, $\frac{1}{2}$ watt
L_1	10 T No. 26 enamel wire close-wound on Millen No. 69042 coil form—tap at 2 T from ground end	R_{20}	7500 ohm 4 watt (two 15,000 ohm 2 watt in parallel)
L_2	5 T No. 26 enamel wire close-wound on Millen No. 69042 coil form	R_{21}	5000 ohm potentiometer (with switch S_2 attached)
L_3	4 T No. 14 wire space wound; one-half inch in diameter; self-supporting	R_{23}	560 ohm, 2 watt ($\pm 10\%$)
L_4	Millen No. 69042 coil form wound full, one layer, with No. 36 enamel wire—tap one-fourth of coil from ground end	RFC ₁ , RFC ₂	Six-meter r.f. choke (Ohmite Z-50)
R_1	16,500 ohm, 4 watt (two 33,000 ohm, 2 watt in parallel)	S_1	SPST toggle
		S_2	SPST (attached to R_{21})
		T_1, T_2	465 kc. I-F transformer altered to 5 megacycles as per text
		T_3	Output transformer, 10,000 ohms to voice coil (UTC R-38A)

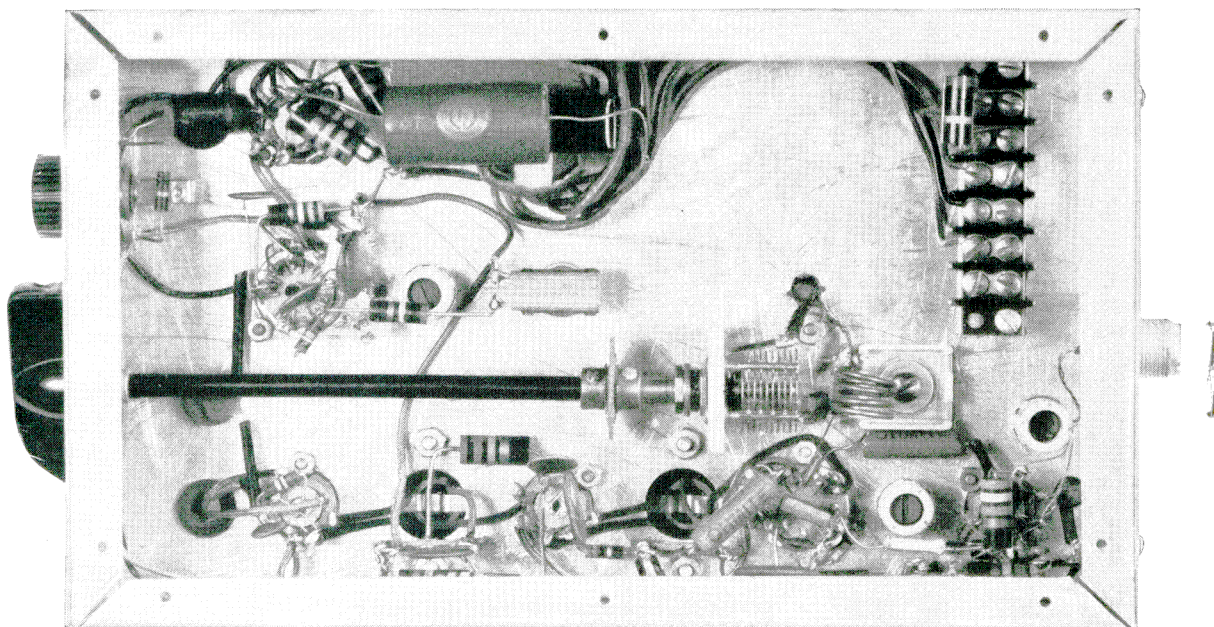

Fig. 3. Underchassis view of the 6-Meter CD Receiver

COMPONENT PARTS

Most of the resistors specified may have a tolerance of 20 percent. A few of them, however, must be ten percent tolerance. These are in *bold-face* type in the Circuit Constants list.

Condensers C_6 , C_{10} , and C_{15} are specified as 2 mmf silver mica condensers. Stability is needed and silver mica condensers are recommended. However, if you wish, you may substitute a length of twisted wire in each case, as long as you make sure that the capacitance stays fixed.

The output transformer may be any type which you can find which will match a 10,000 ohm load to a speaker voice coil. This item is not critical in any respect.

CONSTRUCTIONAL DETAILS

The cabinet and chassis are home-made, and are of a size to match the chassis and cabinet employed in building the 6-Meter Transmitter described in the January-February 1952 *Ham News*. Cabinet size and shape is not too important, although you should follow the layout of the parts as closely as possible. There is no substitute for a tried and proven mechanical layout.

Fig. 5 shows the layout of the major parts on the chassis. Hole dimensions are not given in most cases as they will vary depending on type of socket used and type of i.f. transformer used. Front-panel layout is indicated in Fig. 7. No layout is given for the rear panel, as the location of the coaxial connector and the hole for leads is shown clearly in Fig. 1.

Chassis size is ten by six by three inches. Material is 0.030 or 0.040 aluminum. Front and rear panel size is 6 inches wide and seven and a half inches high. Material is 20 gage iron. Bottom plate size is ten by six inches, and the material is 20 gage iron. The top cover piece is in the form of an inverted "U," and of a size that completely covers the box. Material is 22 gage iron. All pieces are held together with sheet-metal (self-tapping) screws.

Inasmuch as five-megacycle I-F transformers of the desired type are virtually unobtainable, it is

necessary to purchase 465 kilocycle I-F transformers and convert them. Practically any low-frequency I-F transformer is suitable which does not have an iron-core form. Burned-out transformers would be ideal, as long as the mica trimmer condensers in them are in good condition. The transformers used in this receiver are Meissner "Plastic" I-F Transformers. The transformers are $1\frac{1}{4}$ inches square and $2\frac{1}{2}$ inches high and are rated for the frequency range from 400 to 550 kilocycles. Three types are available: input, output and interstage, any of which can be used because you are going to remove the coils anyway. The numbers of these three transformers are: 16-6658, 16-6659 and 16-6660.

Regardless of the type of transformer you procure, make certain that you do *not* get an iron-core unit. Further, try to get transformers that have a coil-form $\frac{3}{8}$ to $\frac{1}{2}$ inch in diameter. The coil-form in the Meissner transformers just described has a $\frac{3}{8}$ inch diameter. It is necessary to enlarge this to $\frac{1}{2}$ inch diameter, but this is easily done by winding the form with paper until it is the right diameter, then putting on a final layer of transparent tape. Now, follow the sketch of the windings shown in Fig. 8, and wind each coil with 40 turns of No. 30 silk or enamel wire. The spacing between coils is $\frac{5}{8}$ inch, as shown, and the wire is close-wound. The 40 turns of close-wound No. 30 wire should just take up the $\frac{3}{8}$ inch winding space shown. For proper connections, follow the color coding shown in the circuit diagram and that shown in Fig. 8. After the coils are wound a small amount of cement may be applied to them to hold the wire in place. If the I-F transformers do not tune to 5 megacycles make any necessary changes only in the trimmer condensers, leaving the coil as specified.

In the under-chassis view, Fig. 3, a terminal strip will be seen. This is the main terminal board for the receiver, and is the point to which external voltages are connected. Only five of the six points are used. These five terminals are: two speaker terminals, B plus, ground, and filament. No switch is provided for the B plus voltage, because most installations will have a relay or a switch for this purpose on the

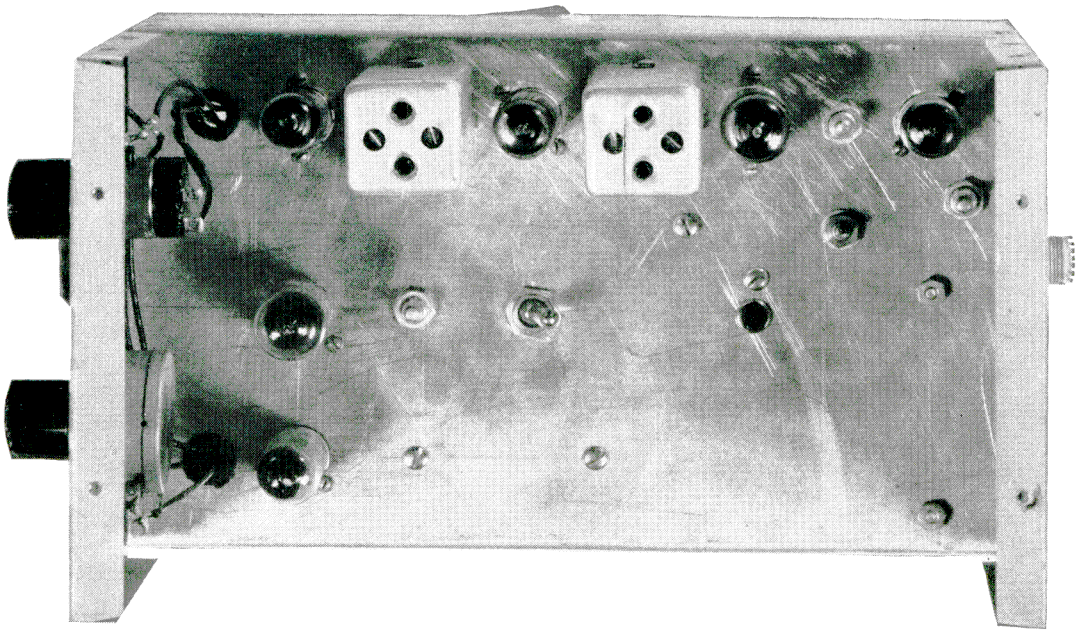

Fig. 4. Top view of 6-Meter CD Receiver

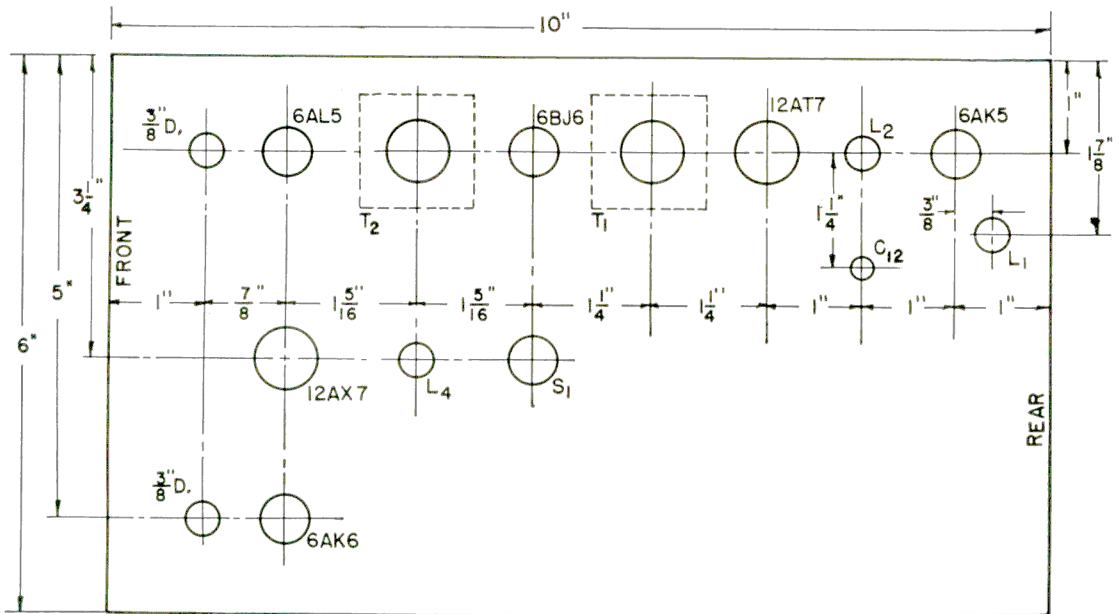

Fig. 5. Chassis layout of 6-Meter CD Receiver

transmitter itself.

In the same photograph you will see a 2-watt resistor connected across the speaker terminal points on the terminal strip. This resistor is not shown in the circuit diagram. It is a load resistor of approximately ten ohms which is used to provide a load for the secondary of the output transformer. This resistor must always be in place when headphones are being used, unless a speaker is being used simultaneously. The secondary of the transformer must never be unloaded when in use.

TUNE-UP PROCEDURE

If you have a grid-dip meter its use is highly recommended. Set L_1 to either 50.55 or 53.55 megacycles. Do the same with L_2 . Next, set C_{12} to half-mesh and tune C_{12} until L_3 is resonant to either 55.55 or 58.55 megacycles.

Next, apply filament and plate voltage, after connecting an antenna and a speaker (or a load resistor across the speaker terminals). Connect an output meter across the speaker terminals, or across the load resistor. Set the grid-dip meter at 50.55 or 53.55

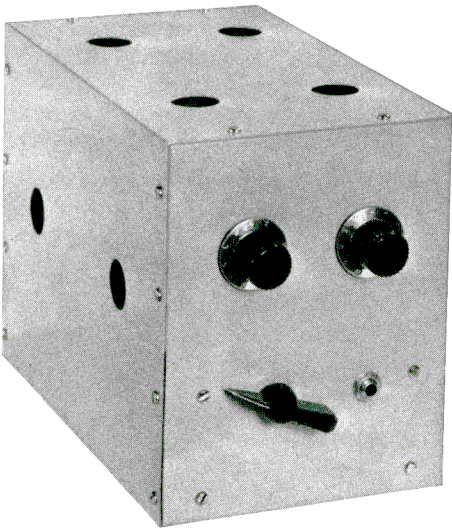

Fig. 6. Front panel view of 6-Meter CD Receiver. ANL control at upper left, gain control at upper right.

megacycles, or use any stable signal at this frequency as a signal source. You may now align the i.f. transformers, adjusting the four trimmers for maximum deflection of the output meter. The r.f. gain control should be set to as low a point as possible to avoid overload. Increase the intensity of the r.f. signal, either by moving the grid-dip meter closer to the receiver, or by advancing the gain on the signal generator, and make certain that the output meter shows an increase in reading. This is a check against overload. If an increase in r.f. signal does not give an increase in meter reading, you are overloading the receiver and you must decrease the r.f. input.

The two I-F transformers will now be operating approximately on the same frequency, so the next step is to set this frequency to 5.0 megacycles. Use a signal generator capable of operation on 5.0 megacycles. You may check its frequency against WWV if you so desire. Connect the output of this signal generator to pin 2 of the 12AT7 through a 100 mmf condenser, and advance the control on the signal generator until you get a suitable deflection on the output meter. Now adjust the four trimmers in the two I-F transformers again, in order to get a maximum reading on the output meter. If the output meter tends to go off-scale, reduce the input by the control on the signal generator. The I-F strip should now be aligned.

Next, remove the I-F signal generator and put a signal into the receiver with an r-f signal generator, and if you are using an adjustable condenser of twisted wire for C_6 , adjust this until you get a maximum signal in the output meter. This capacitance can be too low or too high, so search for the optimum point. Finally, retune L_1 and L_2 slightly to achieve maximum reading of the output meter.

The next step is to turn on the BFO and tune the receiver to the frequency of the signal generator, and listen to the beat-note obtained. Adjust C_{19} , assuming you are using a twisted-wire capacitor, until the beat note is the desired strength. If you do not hear a beat, adjust L_4 until a beat appears. Tune L_4 slowly, as the frequency change is quite rapid when tuning this coil. The receiver should now be ready to put on the air.

If you find that the tuning range is not 200 kilocycles, then you must readjust the value of C_{10} . The

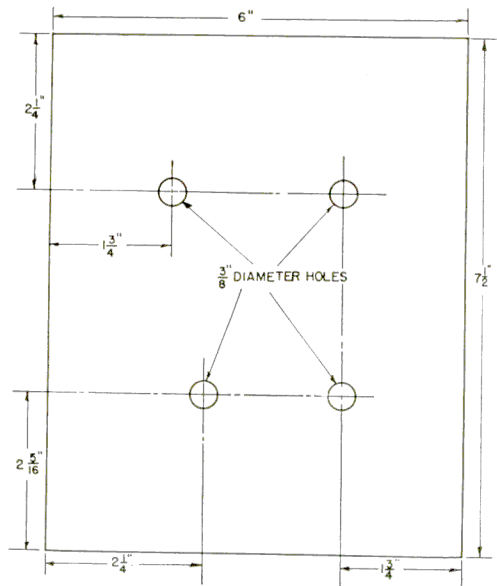

Fig. 7. Front panel layout

larger you make C_{10} , the greater the frequency range, and vice versa.

OPERATING INFORMATION

Use a good antenna, and one with the proper impedance—52 ohms. When properly constructed this receiver will have a noise figure of about 6 db, which means that it is a sensitive receiver.

The noise limiter is the threshold type, which means it must be adjusted according to the strength of the received signal. If you experience noise, turn R_{21} until the switch operates, and advance the control until the noise is just equal to the received signal. If the control is advanced further, you will clip the signal as well as the noise, and the receiver may block.

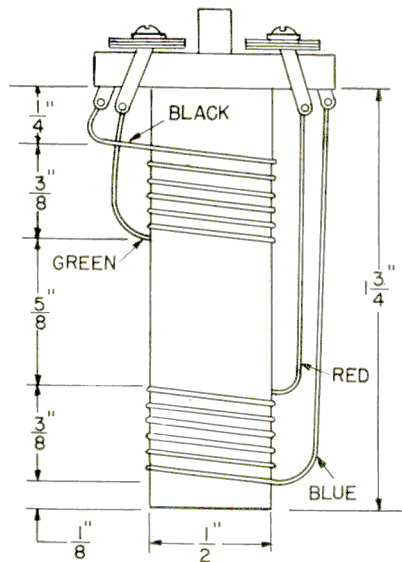
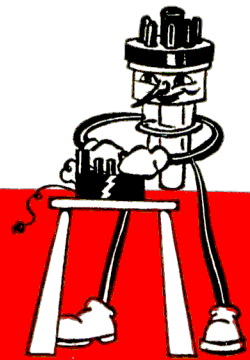

Fig. 8. Detail of I-F coil winding

SWEEPING *the* SPECTRUM



With this issue the G-E *Ham News* starts its seventh year of publication. Almost two and a half million copies of this publication have been printed in that time. In the past 36 issues I have tried to cover most of the phases of amateur radio. If you feel that any subject has been slighted, write and tell me.

The *Ham News* is available, free, from your nearest General Electric Tube Distributor. In the event that you find it difficult to obtain in this manner, a subscription plan is in effect. For \$1.00, the *Ham News* will be sent to you for one year. (This offer open only in continental USA, Alaska and Hawaii.) Address all inquiries and subscriptions to me in Bldg. 267, General Electric Co., Schenectady, N. Y.

✱ ✱ ✱

One of my readers, W9UIM of Sturgeon Bay, Wisconsin, wrote in to vote on the 6-meter receiver, and at the same time mentioned that he suspected that I wasn't too interested in the vote, but that I just wanted to get some mail. I'm glad my secretary didn't see that note! Honestly though, Murray, the last thing we need here is more mail. Around the Christmas season I was literally snowed under with mail, and I'm just getting out from under that group of letters now. Fortunately, the votes that came in didn't require an answer, so I was glad to get all of them.

✱ ✱ ✱

Another one of my readers, W ϕ JMB of Colorado Springs, Colorado, writes in asking how he can possibly get his vote in by Feb. 15 when he didn't receive his copy of *Ham News* until Feb. 19. I'm glad you brought that up, Jim, because it gives me a chance to explain something. The January-February 1952 issue was due to be shipped to distributors and subscribers on January 5. The printing had been complete, and the issue was all set to be shipped, when for some inexplicable reason the gears didn't mesh in the shipping routine and the issue did not get shipped until February 5.

I regret the shipping delay. Does the fact that you received your March-April issue on time help any?

✱ ✱ ✱

Farther down in the mail pouch I find a letter from a California reader. His comments on civil defense work are so interesting that I want to quote them: "Thanks, too, for emphasizing the CD work. I find that Mr. Average Civilian, right here, living and working in an area surrounded with Lockheed, North American and other plane plants, naval stores, testing fields, key refineries and avion-fuel plants—*is still blissfully sleeping*—perfectly confident that *it could not happen here.*"

I, personally, have been quite pleased at the way the amateurs in many communities have begun to do a first-class job in civil defense communication work. I was also quite overwhelmed at the number of votes I received asking that the 6-meter civilian-defense receiver information be published as soon as possible. Thanks to those of you that took the time to write.

✱ ✱ ✱

A recent news release from Electronics Park (the home of General Electric's Electronic Division in Syracuse) tells about the new microwave communication system being installed by G.E. for the Transcontinental Gas Pipeline Corporation. This microwave line extends from Houston, Texas, to Newark, New Jersey. Further, the news release goes on to say that about 15,000 miles of microwave relay systems are currently in operation or under construction for some 20 oil and gas pipeline corporations and other utilities.

G.E. now manufactures and has available two types of microwave equipment. One operates in the 2000 megacycle band and the other in the 960 megacycle band. The reason for telling you this is not to sell you any microwave equipment, but rather to bring to your attention that at least one company (G.E. in this case) is doing a regular business of selling commercial gear to operate at these frequencies. Here is a case where the amateurs are ceasing to be pioneers. A commercial company is selling equipment for use at 2000 megacycles, and yet very few hams have even been on the air in this portion of the spectrum.

The 2300 megacycle amateur band was first used for two-way communication by W2RMA and W2RYT on April 29, 1946. Since that time other experimenters have had equipment in use on that band, but the interest in it seems to be very small. If you, as an amateur, are looking for fields to pioneer in, don't forget the UHF spectrum.

✱ ✱ ✱

The tiny two-way wrist radio used in the Dick Tracy comic strip may be nearer to reality than you think. Mr. I. J. Kaar, manager of engineering for Electronic Division said that the development of tiny electronic components known as transistors have brought tiny radios like those used by the comic strip character within the realm of possibility. He said that a really personal radio of hearing aid size running indefinitely on one set of batteries is within sight.

It's nice to know that electronics is making such giant strides. However, I'll bet a new GL-810 against a soldering lug that it will be some few years yet before we can get a kilowatt rig to fit on our wrist.

—Lighthouse Larry

RADIO-FREQUENCY AMPLIFIER PENTODE

GENERAL DESCRIPTION

Principal Application: The 6BJ6 is a miniature, remote-cutoff pentode designed for use as a high-gain radio-frequency or intermediate-frequency amplifier. Features of the 6BJ6 include low grid-plate capacitance and relatively high transconductance. The low heater current of 150 milliamperes makes the tube particularly suitable in applications where conservation of heater power is important. The electrical characteristics of the 6BJ6 are similar to those of the 6BA6.

Cathode.....Coated Unipotential
 Heater Voltage (A-c or D-c).....6.3 Volts
 Heater Current.....0.15 Ampere
 Envelope.....T-5½ Glass
 Base.....E7-1, Miniature Button 7-pin
 Mounting Position.....Any

Direct Interelectrode Capacitances:

	With Shield*
Grid to Plate (Max).....	0.0035
Input.....	4.5
Output.....	5.5

* With external shield No. 316 connected to pins 2 and 7.

PHYSICAL DIMENSIONS

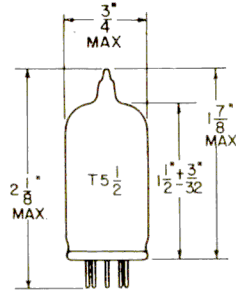

BASING DIAGRAM

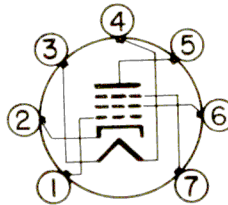

TERMINAL CONNECTIONS

- Pin 1—Grid Number 1
- Pin 2—Cathode
- Pin 3—Heater
- Pin 4—Heater
- Pin 5—Plate
- Pin 6—Grid Number 2 (Screen)
- Pin 7—Internal Shield and Grid Number 3 (Suppressor)



Ham News

Available FREE from
 G-E Electronic Tube Distributors

Printed in U.S.A.

A Bi-monthly Publication

TUBE DEPARTMENT, ELECTRONICS DIVISION

GENERAL ELECTRIC

SCHENECTADY 5, N. Y.

(In Canada, Canadian General Electric Company, Ltd., Toronto, Ont.)

GEO. H. FLOYD, W2RYT—EDITOR

FROM: